

AVENGER™

Model 95



Applications

- ▶ Continuous sampling in any process industry including natural gas, petrochemical, and oil refining.
- ▶ Analyzer protection against micron and sub-micron particles

Benefits

- ▶ Helps preserve sample integrity
- ▶ Analyzer protection
- ▶ Quick and easy to install and maintain
- ▶ Quick and easy element inspection
- ▶ Economical
- ▶ Flexible installation configuration

Features

- ▶ 3 or 5 port configuration
- ▶ Can be mounted horizontally or vertically
- ▶ All primary connection ports on the head

Quick Study

The Avenger™ 90 Series Filters provide the utmost in flexibility for your coalescing and particulate filtration needs. The conventional 3-port model is a direct replacement for competitive vertically mounted sample filters. However, the 5-port model, with its two different porting configurations allows for greater mounting and application flexibility. These filters were specifically designed for analyzer sample conditioning applications by analyzer sample conditioning specialists.

The Avenger™ Model 95 is the high-pressure version of the Model 91. The walls of the bowl are thicker than the Model 91 giving it lower internal volume ideal for high-pressure applications. Additional information such as Application Notes is available.

Technical Specifications

Maximum pressure rating	5,000 psig
Maximum recommended supply pressure	Lowest possible pressure consistent with application
Element maximum temperature	302 °F (150 °C) for 07PF 450 °F (232 °C) for 07PI 450 °F (232 °C) SS10A 450 °F (232 °C) SS100A
Element size	Outside Diameter: ~ 0.85" Inside Diameter: ~ 0.5" Length: ~ 2.3"
Element types	07PI = particulate inorganic (99.97%*) 07PF = particulate fluorocarbon (99.97%*) 11PF = particulate fluorocarbon (95.0%*) SS10A = sintered stainless steel (10 micron) SS100A = sintered stainless steel (100 micron) *% of 0.1 micron particles retained
Port sizes	1/4" female NPT
Number of ports	3 or 5
Internal volume	17 cc
Wetted materials	Machined parts : 316 stainless steel / NACE compliant All other metal parts: stainless steel / NACE compliant Sealing material: Viton® standard



An ISO 9001:2000 certified company



Genie® and Avenger™ are trademarks or registered trademarks of A+ Corporation, LLC.
All other referenced trademarks are the property of their respective owners.



Model Numbering & Additional Part Numbers

Your model number is determined by your specific needs. Choose options below.



Port configuration*	2/1 = 3 port (2 outer, 1 center)	4/1 = 5 port (4 outer, 1 center)	3/2 = 5 port (3 outer, 2 center)
Sealing material 	0 = Viton®	1 = Kalrez®	(other materials available upon request)
Element type	07PI = 0.1 micron particulate inorganic 07PF = 0.1 micron particulate fluorocarbon 11PF = 0.1 micron particulate fluorocarbon	SS10A = 10 micron stainless steel SS100A = 100 micron stainless steel XX = no element	
Mounting bracket accessory	Vertical part # = 90-509-SS-V	Horizontal part # = 90-509-SS-H	

How to build the model number:



 Port configuration*
 Sealing material
 Element type

*Port Configurations:

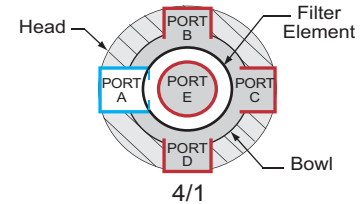
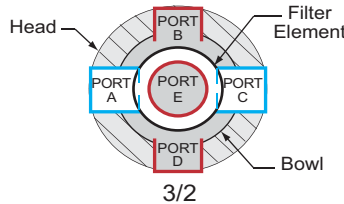
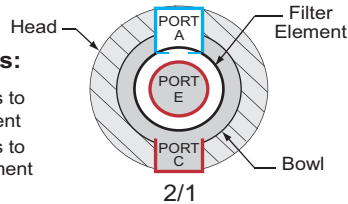

-  Communicates to inside of element
-  Communicates to outside of element

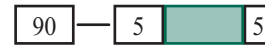

How to build the replacement filter element number



Element type

 We cannot recommend specific sealing materials due to the complex nature of sample stream compositions. Temperature and pressure also may be factors.
 Unless specified otherwise, the product will ship with our standard sealing materials and materials of construction stated in the technical specifications section of the corresponding Product Sheet.  Please refer to www.dupontelastomers.com for sealing material recommendations and advice. It is the user's responsibility to specify the sealing materials and other materials of construction for their application.

Dimensions

Back View

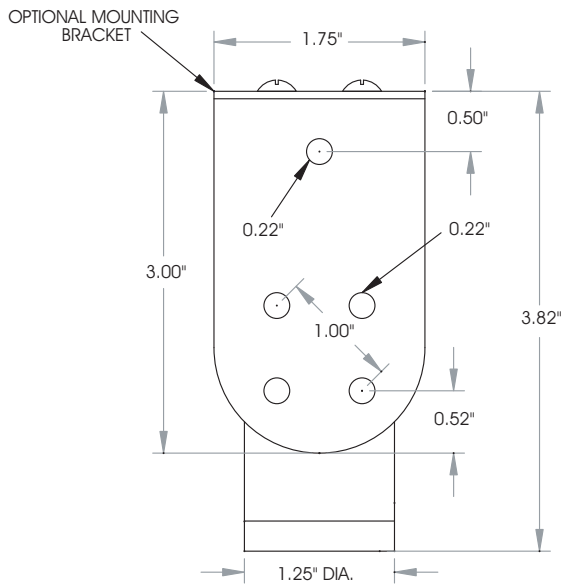

Side View

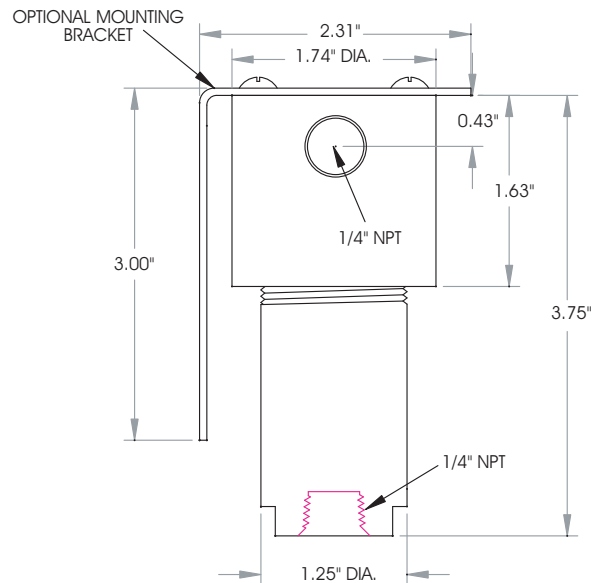

Local Distributor:

Manufacturer

A+ Corporation, LLC

41041 Black Bayou Road

Gonzales, LA 70737

Call for expert product application assistance:

Phone: (225)-644-5255 Website: www.geniefilters.com

Fax: (225)-644-3975 E-mail: sales@geniefilters.com



An ISO 9001:2000 certified company

©2010 A+ Corporation, LLC. All rights reserved.

SCC-Avenger95-PS_0610